

Performance evaluation of OOK and BPSK modulation schemes for IR-UWB receiver using wide band LNA

Madiha Hajri^{#1}, Nadia Gargouri^{*2}, Dalenda Ben Issa^{*3}, Hekmet Samet^{#4}

[#]University Laboratory LETI-ENIS,
University of Sfax,

Sfax, Street of Soukra 3.5Km, BP.3038, Tunisia

Performance evaluation of OOK and BPSK modulation
schemes for IR-UWB receiver using wide band LNA

¹ hajrimadiah@gmail.com

⁴ hekmet.samet@enis.rnu.tn

³ dalenda_benissa@yahoo.fr

Abstract— Ultra wide band systems are considered as one of the most exciting technologies due to its capability of transmitting data over a wide frequency spectrum with very low power and high data rates. In any UWB receiver the low noise amplifier is the first stage. The LNA plays a crucial role in the whole reception chain. In this paper, we examine the performance of two different modulations techniques in UWB receiver with a wide band LNA. This LNA is designed by a TSMC 0.18 μm . The wide band LNA achieves the gain S_{21} of 12.5dB and a noise figure NF of 2.4 dB. In this work we evaluate the bit error rate BER of two different modulations with UWB Gaussian second derivative in the presence of the additive white Gaussian noise AWGN channel. The simulation results demonstrate that the OOK modulation technique provides better performance in comparison to the BPSK modulation.

Keywords— wide band LNA, BER, BPSK, OOK, UWB

I. INTRODUCTION

UWB technology has become more popular for broadband wireless communication research due to its characteristics of low power dissipation, high data rates, robustness for multipath fading, low cost and extremely low interference as compared with conventional narrow band communication systems. However, the Federal Communication commission (FCC) has allocated 7500 MHz bandwidth in the frequency range of 3.1-10.6 GHz. The related technologies have attracted much attention from both industry and academia[1]. UWB can be used in military applications due its low power spectral density. Other common uses of UWB are in radar and imaging technologies, where the ability to resolve multipath delay is in the nanosecond range. There are different schemes of UWB system such as OFDM or impulse radio UWB[2]. In this work impulse radio (IR) UWB system is investigated for UWB system methods are proposed such us pulse position modulation (PPM), binary phase-shift keying (BPSK) and on-off keying (OOK).

In this paper the BPSK and OOK modulation are used. The bit error rate performance of BPSK-UWB and OOK-UWB receiver with a wideband LNA and with additive white Gaussian noise (AWGN) environment is evaluated.

The paper is organized as follows. Section II, we describe the details of the OOK, BPSK modulation techniques. Wide band LNA design details are provides in section III. The result

of the BER performance of UWB receiver is presented in section IV. Finally the conclusions are drawn in section V.

II. UWB PULSE AND MODULATION SCHEME

UWB signal uses baseband pulses of very short time duration in the range of a few hundred picoseconds[2]. There are different modulation techniques for UWB. This paper uses On-Off Keying OOK and Binary Phase Shift Keying BPSK modulation for UWB receiver.

In the UWB communication system, the most widely used pulse shapes are the Gaussian pulses, wavelet-based monocycle and Manchester monocycle[3]. The choice of the pulse shape is very important in the design and implementation of UWB communication systems. In this work, Gaussian second derivative is considered as UWB signal and the transmission of this signal affects the performance of different modulation in the presence of AWGN channel.

We use the second order Gaussian pulse because it is the most currently adopted pulse that meets the appropriate UWB operation which is usually generated by this equation.

$$w(t) = 2 \frac{A}{\tau} \sqrt{e} (T - T_c) e^{-2 \left[\frac{T - T_c}{\tau} \right]^2} \quad (1)$$

The MATLAB program involves pulse generation with the help of Gaussian 2th derivative which can be shown in Fig.1. In Fig.1, a sequence of $T_f = 1\text{ns}$ duration frame is shown. The generation wave form has duration $T_p = 2\text{ns}$

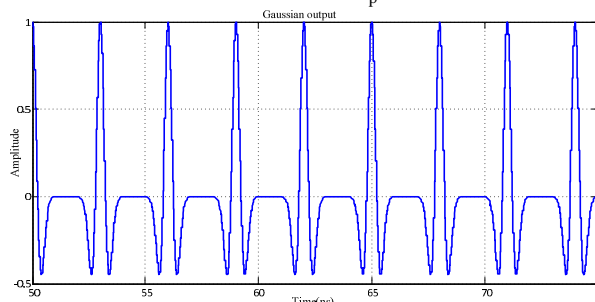

Fig. 1 Time domain representation of the second derivative Gaussian pulse Generator

A. OOK modulation

In OOK modulation scheme data symbol indicates “1” the presence of a pulse and data symbol “0” indicates no pulse[4]. The equation of the OOK modulated signal can be expressed as:

$$S^k(t) = \sum_j d^k w(t - jT_f) \quad (2)$$

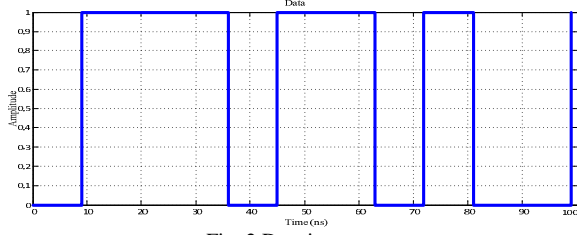

Fig. 2 Data input

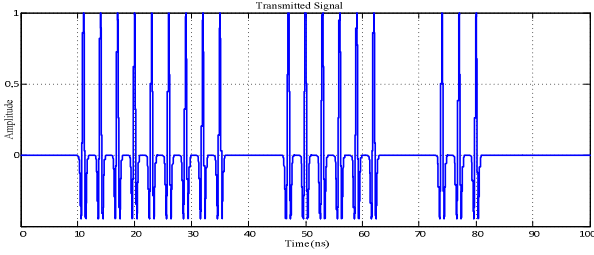

Fig.3 Time domain representation of the OOK transmitted signal

B. BPSK modulation

In the BPSK modulation scheme the data is carried in the polarity of the pulses. The phase value of zero degrees indicate the data symbol “1” and 180 degrees phase value indicate the data symbol “0”[5]. BPSK data modulation can be expressed as follow

$$S^k(t) = \sum_j w(t - jT_f - \phi) \quad (3)$$

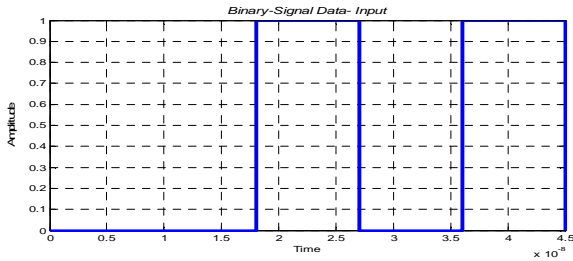

Fig.4 Data input

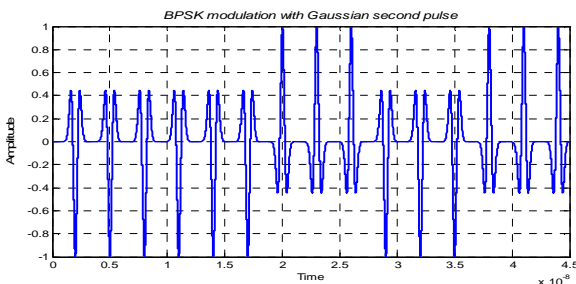

Fig.5 Time domain representation of the BPSK transmitted signal

C. SIMULINK model for AWGN channel

In this work the IR-UWB transceiver system is simulated in the AWGN channel. This section provides more details about the UWB transceiver SIMULINK block diagram and the channel utilized with UWB system.

In order to implement an efficient UWB system it is critical to understand the characteristic of the propagation channel. In this paper, two different modulation schemes and a second derivative Gaussian pulse are chosen carefully and their affects are investigated in the presence UWB technology by using bit error rate (BER) technique. A comparison between the two different modulations is also made with the presence of AWGN.

The AWGN channel block adds white Gaussian noise to a real or complex input signal. If the input signal is real, this block adds a real Gaussian noise and produces a real output signal. When the input signal is complex, this block adds complex Gaussian noise and produces a complex output signal. Changing the Symbol period in the AWGN channel block affects the variance of the noise added per sample, which also causes a change in the final error rate[2].

$$\text{Noise variance} = \frac{\text{Signal Power} * \text{Symbol Period}}{\text{Sample time} * 10^{10} \frac{E_s}{N_0}} \quad (4)$$

The AWGN is a fundamental limiting factor in communication systems, and must be considered in the receiver design. It could be a result of a number of phenomena that include atmospheric noise, RF interference[2]. AWGN probability function (PDF) is expressed as follow

$$p(t) = \frac{1}{\sqrt{2\pi\sigma_v}} e^{-\frac{(v-\bar{v})^2}{2\sigma_v^2}} \quad (4)$$

Where v is the amplitude of the noise samples with a variance of $\sigma_v^2 = 1$ and a mean of $\bar{v} = 0$

D. Transceivers implementation

In the following section the implementation of both OOK and BPSK transceivers are presented. All the simulation are carried and using MATLAB/SIMULINK. Performance analysis and parametric results are discussed in depth after different parametric considerations. The flow chart show in Fig.6 and Fig.7 describe the various functional building blocks that have been used for simulation of the OOK and BPSK transceivers respectively. The various parameters and their values that are used during simulation of results are described in the table below.

III. LNA CIRCUIT DETAILS

The LNA is one of the most critical components of a UWB reception chain. Its role is to amplify the received signal with sufficient gain and as little additional noise as possible to overcome the noise of subsequent stages.

There are three important characteristics in the design LNA for UWB communication system. The first is the wide bandwidth. The second is the implementation of low power with high power gain. The third is related to a uniform gain to avoiding distortion of the signal over the bandwidth. The designed LNA as shown in fig.1 uses the current reuse technique. It is composed of two stages form common source (CS) topology and overall design contract cascode architecture[6],[7],[8].

The objective of the first CS stage is to provide input matching impedance less than 50Ω by selecting appropriate values of R_{FB} , L_{S1} and the channel of M_1 transistor. The input impedance matching is expressed by the following equation.

$$S_{11} = \frac{Z_{in} - R_S}{Z_{in} + R_S}$$

$$Z_{in} = \frac{(L_{G1} + L_{S1}) R_{FB}}{L_{D1} g_{m1}} + S \frac{(L_{G1} + L_{S1})}{g_{m1}} + \frac{1}{S} \frac{(L_{G1} + L_{S1})}{L_{D1} g_{m1} C_1} + \frac{1}{g_{m1} C_{gs1}} + \frac{L_{S1} R_{FB}}{C_{gs1} L_{D1}} \quad (5)$$

The objective of the first stage is to provide noise figure as low as possible by selecting appropriate values for L_{S1} , L_{GS} , M_1 as shown in this equation.

$$NF = 1 + \frac{R_{FB} \left(\gamma g_{m1} + \frac{1}{R_{LD1}} + \frac{S L_{D1}}{R_{FB}} \right)}{S L_{D1} g_{m1}^2 (R_{FB} + S^2 + L_{D1}^2)} \frac{1}{\left(\frac{1}{R_S} + \frac{1}{R_{FB}} + \frac{1}{R_{LG1}} + \frac{1}{R_{LS1}} \right) Z_{in}^2} \quad (6)$$

Whoever, the role of the second stage is to improve flatness of gain by amplifying the output signal of M_1

The gain of the designed LNA is giving by equation 7. From this equation; it is clear that, to achieve high and flat gain by selecting appropriate channel of M_2 , L_{D2} , R_{D2} and L_{G2}

$$S_{21} = g_{m1} g_{m2} \frac{S L_{D1} (S L_{D2} + R_{D2})}{S^2 C_{gs2} L_{G2} + \left(\frac{C_{gs2}}{C_2} + \frac{C_{gs2}}{C_3} \right)} \quad (7)$$

The LNA is designed with TSMC-RF CMOS $0.18\mu\text{m}$ technology. The designed exhibits a balance between impedance matching, figure noise and gain. According to the curve of Fig.9, the LNA achieves a maximum gain of 12.5dB over the 3.1-10.6 GHz bandwidth. As shown in fig.9, the LNA is well suited because $S(2, 2)$ is less than (-10 dB). The values of $S(1, 1)$ expressed in the curve of fig.8 is less than (-10 dB) which indicates a good matching to 50 ohm. The noise figure cure is shown in fig.9, This LNA results a low noise figure between 2.4 dB.

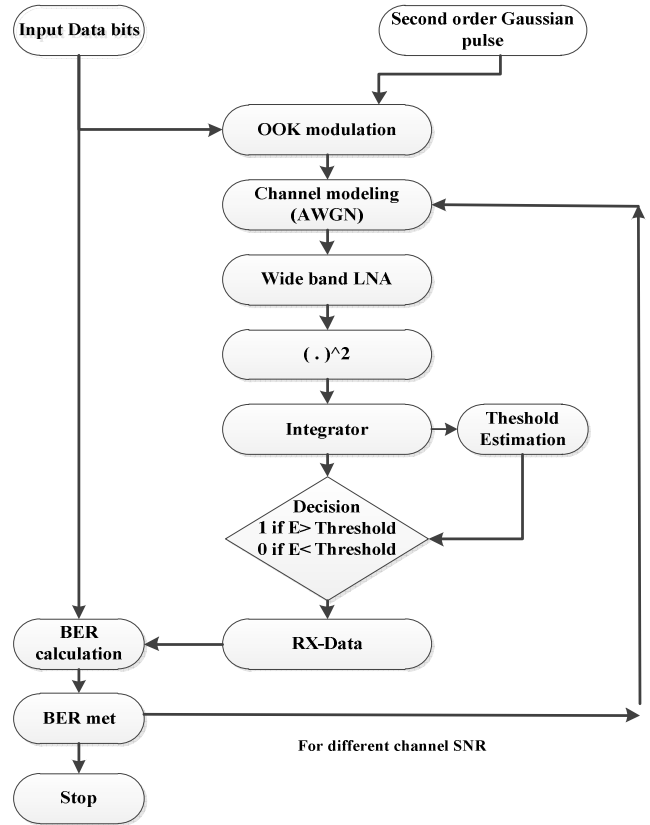

Fig. 6 Flowchart for the simulation of building blocks of OOK transceiver

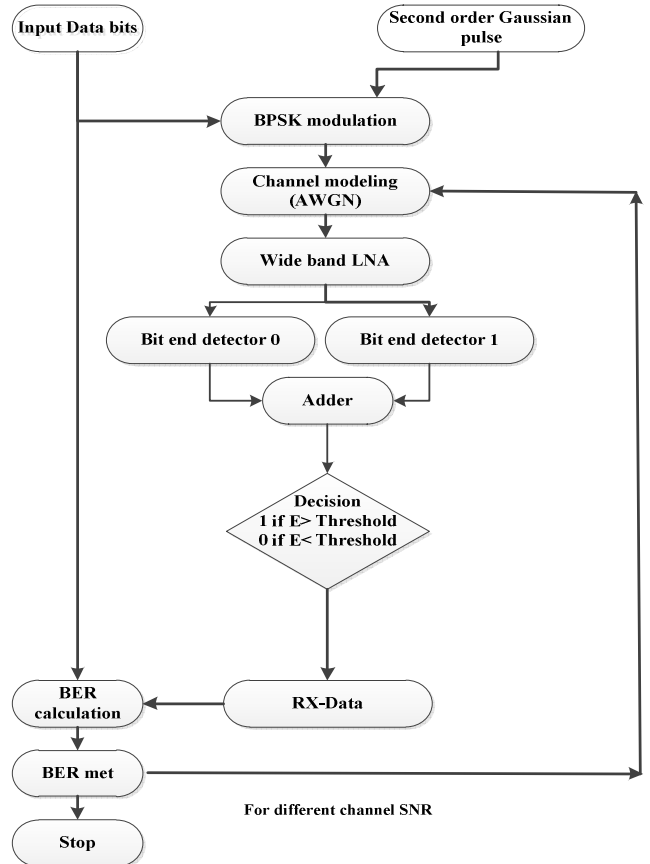

Fig.7 Flowchart for the simulation of building blocks of BPSK transceiver

TABLE I
PARAMETERS VALUES USED DURING SIMULATION

Parameters for Gaussian signal	
Pulse repetition value	1ns
Pulse width	2ns
modulation	OOK
Pulse shape	2 nd order Gaussian
Parameters for the AWGN channel	
Initial seed	1000
mode	Signal to noise ratio (SNR)
Input signal power (watts)	0.314
Parameters for the wide band LNA	
Method	linear
Gain (dB)	12.5
Noise figure	2.4
Initial seed	1234

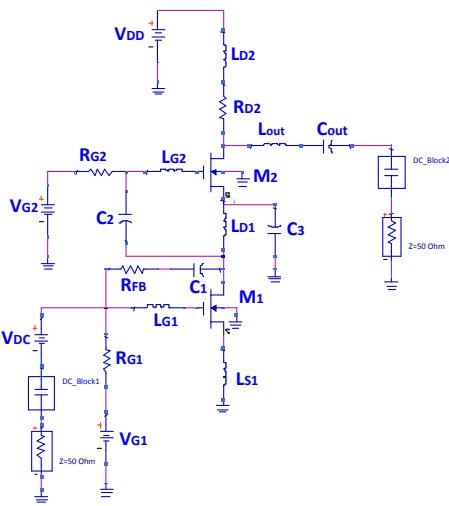

Fig.8 UWB low noise amplifier

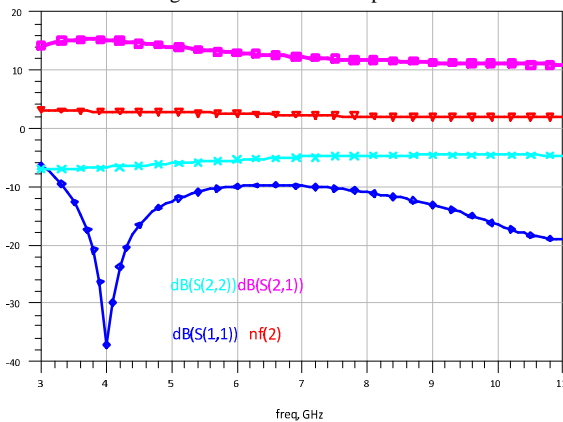

Fig.9 Simulation results of the UWB low noise amplifier

IV. SIMULATION RESULTS

In this paper, two different modulation schemes for UWB communication system with second derivative Gaussian pulse are considered for performance analysis. The performance is evaluated in team of Bit Error Rate in the presence of AWGN channel. The Fig.10 shows the BER performance of IR-OOK and IR-BPSK receivers with the wide band low noise amplifier. It can be noticed from the figure that OOK modulation gives the best performance for second order Gaussian pulse in the presence of AWGN channel.

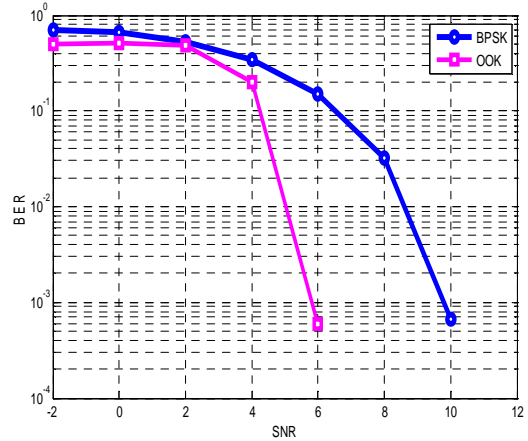

Fig.10 BER performance of UWB transceiver with wide band LNA

V. CONCLUSION

In this paper, we have implemented two different UWB transceivers with SIMULINK model. In this work, we have designed a wide band LNA with Agilent's ADS. This LNA achieves the gain of 12.5 dB. With this low noise amplifier, we have analysed and compared the performance of two different modulation techniques in term of bit error rate . In the presence of AWGN channel, the OOK modulation performs better than the PBSK modulation.

References

- [1] A. Adsul and S. Bodhe, "Design and Performance Evaluation of Transmitted Reference BPSK UWB Receiver using SIMULINK," *Ijcsit.Com*, vol. 2, no. 6, pp. 2752–2760, 2011.
- [2] A. Adsul and S. Bodhe, "Performance Comparison of BPSK, PPM and PPV Modulation Based IR-UWB Receiver Using Wide Band LNA," *Int. J.*, vol. 3, no. August, pp. 1532–1537, 2012.
- [3] T. Ali, P. Siddiqua, and M. a. Matin, "Performance Evaluation of Different Modulation Schemes for Ultra Wide Band Systems," *J. Electr. Eng.*, vol. 65, no. 3, pp. 184–188, 2014.
- [4] S. Mungale and N. Gupta, "Comparative Evaluation of Bit Error Rate (BER) in UWB," vol. 1, no. 4, pp. 100–103, 2014.
- [5] A. K. Thakre and A. I. Dhenge, "Selection of pulse for ultra wide band communication (UWB) system," *Int. J. Adv. Res. Comput. Commun. Eng.*, vol. 1, no. 9, pp. 683–686, 2012.

- [6] M. Hajri, D. Ben Issa, and H. Samet, "New design of 3-10 GHz low noise amplifier for UWB receivers," pp. 7-11, 2015.
- [7] a N. Ragheb, G. a Fahmy, I. Ashour, and a Ammar, "A 3 . 1-10 . 6 GHz Low Power High Gain UWB LNA," pp. 7-10, 2011.
- [8] W. D.-R. L. C. Wideband, Y. Lin, S. Member, C. Chen, H. Yang, C. Chen, J. Lee, G. Huang, and S. Lu, "Analysis and Design of a CMOS UWB LNA," vol. 58, no. 2, pp. 287-296, 2010.